

Kanal Tipi
Radyal Vantilatörler

Seri KTP

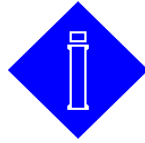

İNCİRCİOĞLU
Vantilatör, Klima İmalat San. ve Tic. Ltd. Şti.



KTP Kanal Tipi Radyal Vantilatörler Ebat Tablosu

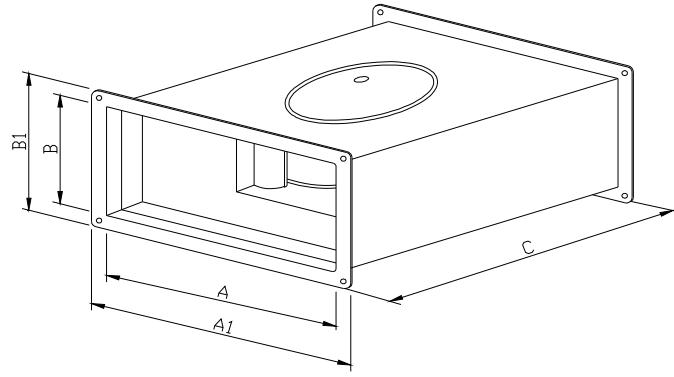

Tip	A	A1	B	B1	C
	mm	mm	mm	mm	mm
KTP 200 2P	400	460	200	260	450
KTP 225 2P	500	560	250	310	480
KTP 250 2P	500	560	300	360	520
KTP 280 2P	600	680	300	380	570
KTP 355 4P	700	780	400	480	670
KTP 400 4P	800	880	500	580	750
KTP 450 4P	800	880	500	580	830

TEKNİK VERİ TABLOSU										
Tip	A	Frekans (Hz)	Max. Hava Debisi (m ³ /h)	Devir (min-1)	Giriş Gücü (W)	Akım (A)	Kapasitör (mF/VDB)	Gürültü Seviyesi (dBA)	Sıcaklık (C)	Ağırlık (Kg)
KTP 200 2P	230	50	885	2700	85	0,38	2,5/400	72	55	1,5
KTP 225 2P	230	50	1200	2650	135	0,6	4,0/450	69	60	2,1
KTP 250 2P	230	50	1450	2600	155	0,7	5,0/400	75	70	3,1
KTP 280 2P	230	50	2110	2700	225	1	7,0/400	76	40	3
KTP 355 4P	230	50	2365	1410	170	0,78	6,0/400	66	55	4,4
KTP 400 4P	230	50	3150	1300	270	1,2	8,0/400	68	45	5,2
KTP 450 4P	230	50	4450	1290	640	3,1	10,0/400	68	50	9,3

Rotor Tipi : Geriye eğik seyrek kanatlı

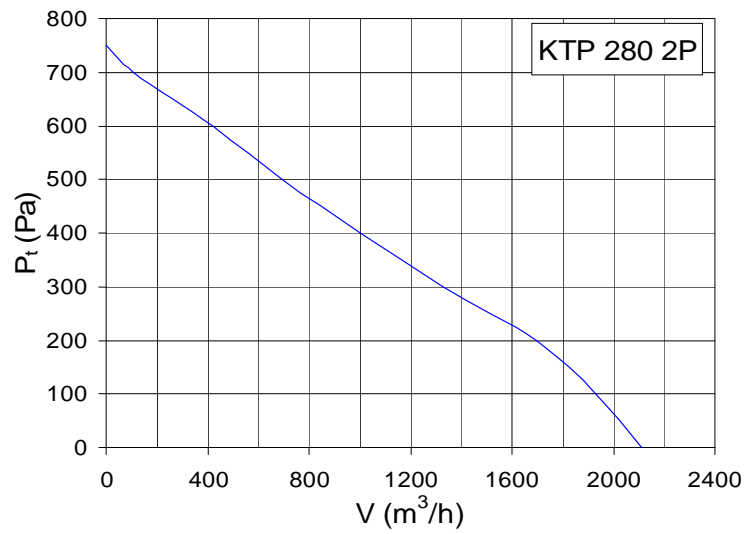
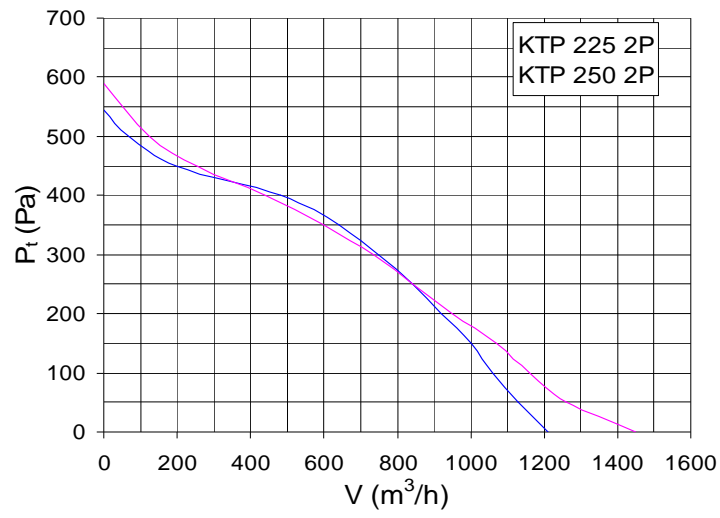
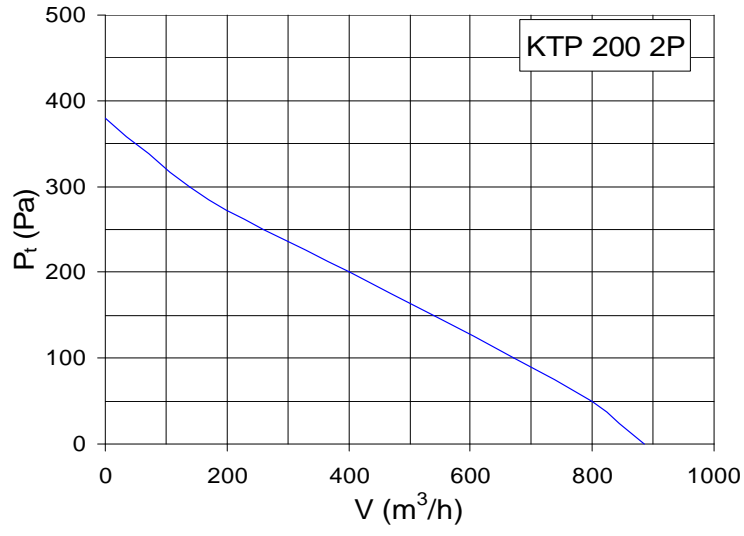

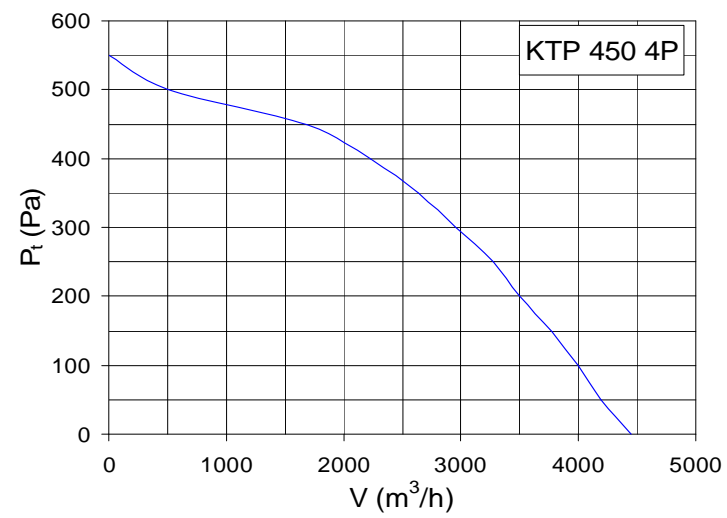
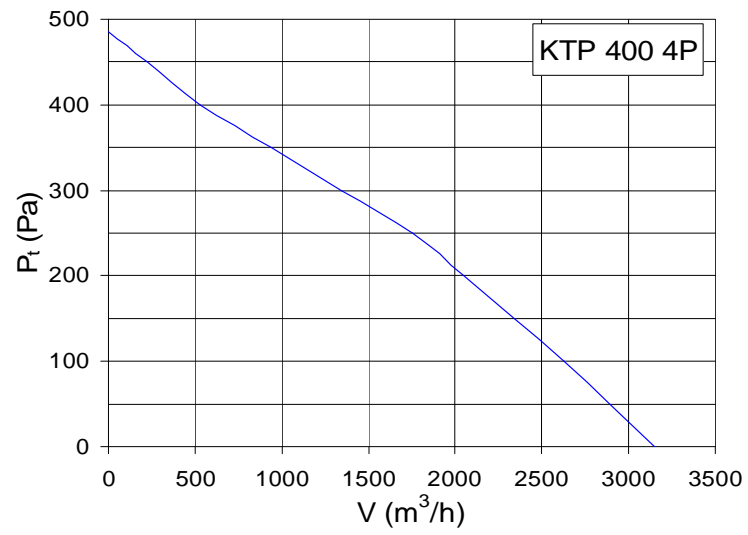
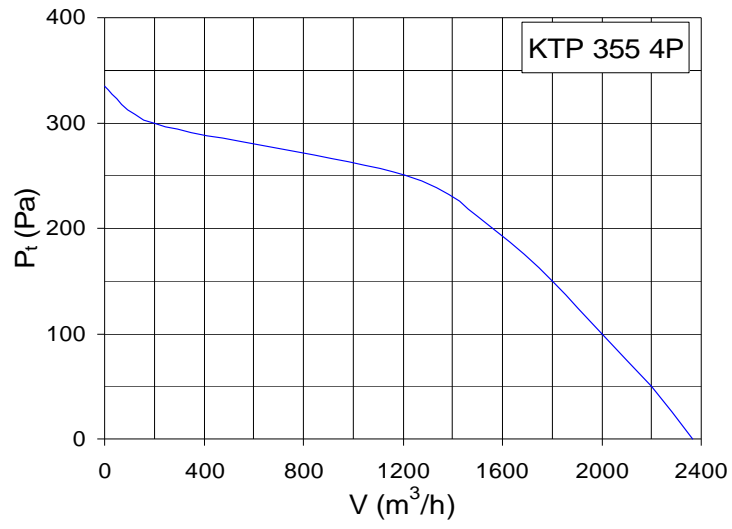

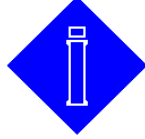

İNCİRCİOĞLU

Vantilatör, Klima İmalat San. ve Tic. Ltd. Şti.

Merkez : Çomançeşme Mahallesi, Sanayi Caddesi
Genç Osman Sokak, No.16
Yenibosna / İstanbul / Türkiye
Tel : (0212) 551 1112
Faks : (0212) 654 2776

Şube : Aşağı Sevindikli Köy Yolu Üzeri
Muratlı / Tekirdağ / Türkiye
Tel : (0282) 373 7088
Faks : (0282) 373 7087

www.incircioglu.com
www.incircioğlu.com.tr
erisim@incircioglu.com

