

High Efficiency Radial Fans

Series VE3

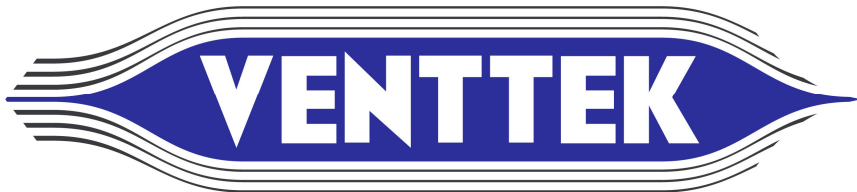
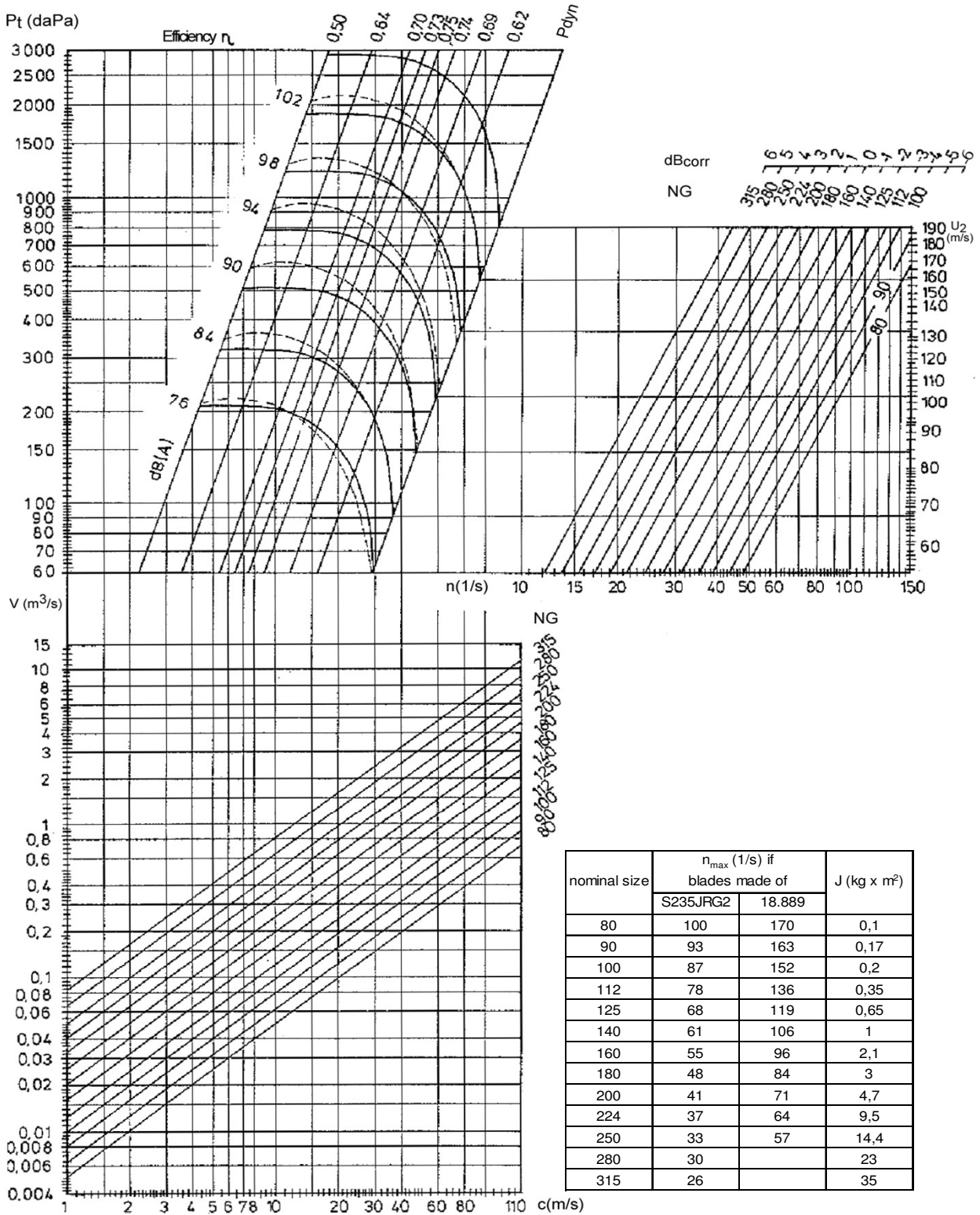

Vantilatör İmalat Sanayi
ve Ticaret Ltd. Şti.

Series VE3 - characteristic curve NS 80 - 315



Spiral housing positions and dimensions

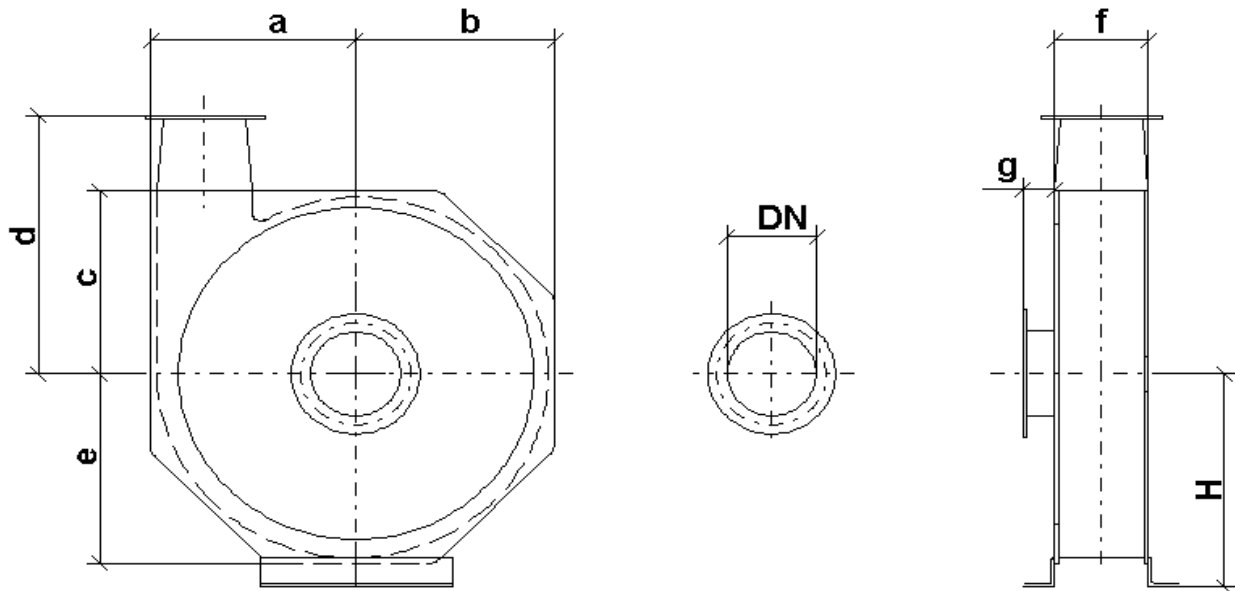

nominal size NS	80	90	100	112	125	140	160	180	200	224	250	
housing position	45°	245	290	320	355	400	445	490	540	600	670	730
	90°	245	290	320	355	400	445	490	540	600	670	730
	135°	245	290	320	355	400	445	490	540	600	670	730
	180°	245	290	320	355	400	445	490	540	600	670	730
	270°	245	290	320	355	400	445	490	540	600	670	730
	315°	245	290	320	355	400	445	490	540	600	670	730
	360°	245	290	320	355	400	445	490	540	600	670	730
nominal inlet Ø	80	90	100	112	125	140	160	180	200	224	250	
nominal outlet Ø	63	71	80	90	100	112	125	140	160	180	200	
spiral housing dimensions	a	225	260	285	320	365	410	455	505	565	630	715
	b	215	250	275	310	350	390	435	485	545	610	690
	c	210	240	270	305	340	385	425	475	535	600	680
	d	335	365	400	430	465	510	550	600	660	730	810
	e	220	255	280	315	355	400	445	495	555	620	700
	f	76	84	94	105	117	131	146	164	183	205	229
	g	50	50	50	50	50	50	50	50	50	50	50

The Venttek-High-Efficiency-Fan Program furthermore contains:

- Industrial fans in radial construction
- Smoke gas fans
- Multiple stage fans
- Pressure and shock resistant fans
- High pressure fans
- Hot gas fans
- Built-in fans without casing
- Portable fans in radial and axial design in explosion proof construction for zone I and II

We would be pleased to give you further information.



Head Office : Çobançeşme Mahallesi, Sanayi Caddesi
Genç Osman Sokak, No.16
Yenibosna / İstanbul / Türkiye
☎ : (0212) 551 1112
Fax : (0212) 654 2776

Factory : Aşağı Sevindikli Köy Yolu Üzeri
Muratlı / Tekirdağ / Türkiye
☎ : (0282) 373 7088
Fax : (0282) 373 7087

✉ : info@incircioglu.com
www.venttek.com
www.incircioglu.com

