

High Efficiency Radial Fans

Series VE5S

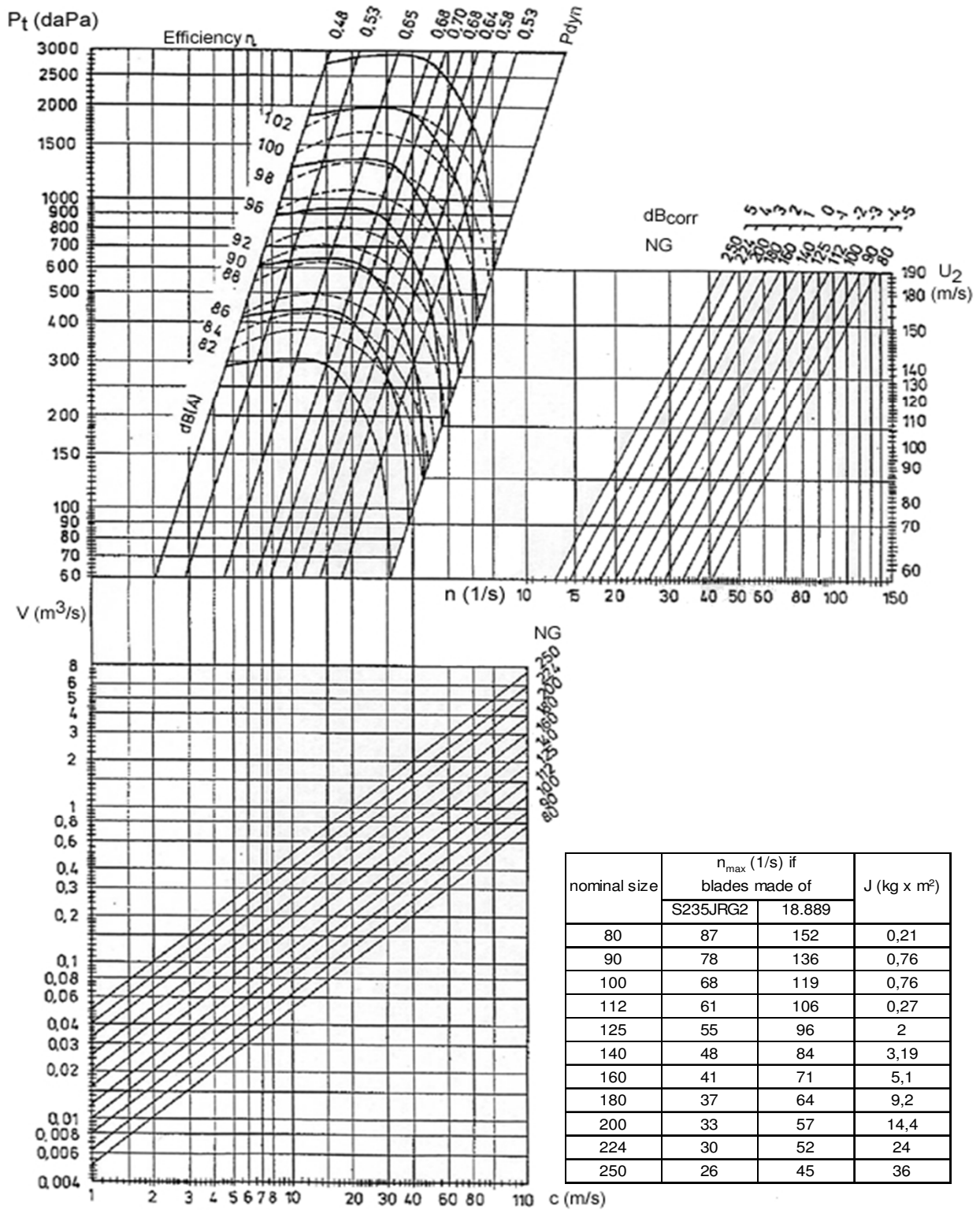

Vantilatör İmalat Sanayi
ve Ticaret Ltd. Şti.

Series VE5S - characteristic curve NS 80 - 250



Spiral housing positions and dimensions

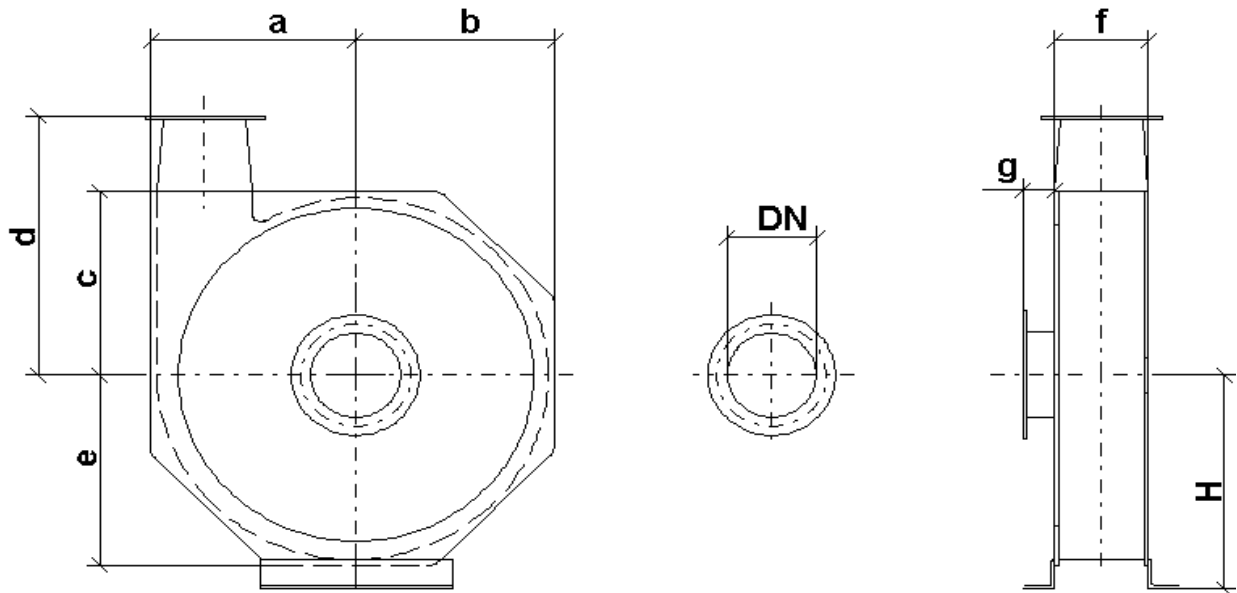

nominal size NS	80	90	100	112	125	140	160	180	200	224	250	
housing position	45°	320	355	400	445	490	540	600	670	730	850	930
	90°	320	355	400	445	490	540	600	670	730	850	930
	135°	320	355	400	445	490	540	600	670	730	850	930
	180°	320	355	400	445	490	540	600	670	730	850	930
	270°	320	355	400	445	490	540	600	670	730	850	930
	315°	320	355	400	445	490	540	600	670	730	850	930
	360°	320	355	400	445	490	540	600	670	730	850	930
nominal inlet Ø	80	90	100	112	125	140	160	180	200	224	250	
nominal outlet Ø	56	63	71	80	90	100	112	125	140	160	180	
spiral housing dimensions	a	285	320	285	410	455	505	565	630	715	810	900
	b	275	310	275	390	435	485	545	610	690	780	870
	c	270	305	270	385	425	475	535	600	680	770	850
	d	395	430	400	515	550	600	660	730	810	900	980
	e	280	315	280	400	445	495	555	620	700	800	880
	f	68	76	94	94	105	117	131	146	164	183	205
	g	50	50	50	50	50	50	50	50	50	50	50

The Venttek-High-Efficiency-Fan Program furthermore contains:

- Industrial fans in radial construction
- Smoke gas fans
- Multiple stage fans
- Pressure and shock resistant fans
- High pressure fans
- Hot gas fans
- Built-in fans without casing
- Portable fans in radial and axial design in explosion proof construction for zone I and II

We would be pleased to give you further information.



Head Office : Çobançeşme Mahallesi, Sanayi Caddesi
Genç Osman Sokak, No.16
Yenibosna / İstanbul / Türkiye
☎ : (0212) 551 1112
Fax : (0212) 654 2776

Factory : Aşağı Sevindikli Köy Yolu Üzeri
Muratlı / Tekirdağ / Türkiye
☎ : (0282) 373 7088
Fax : (0282) 373 7087

✉ : info@incircioglu.com
www.venttek.com
www.incircioglu.com

